

pure
storage
reimagined



an industry first

the pure manufacturing plant, here in the UK, is the first carbon zero manufacturing facility in our industry.



revolutionary production

By investing in the most modern manufacturing machinery currently available in Europe, we can boast the most efficient steel locker manufacturing facilities in the UK. Our world class production facility utilises the latest in data driven technology placing Pure firmly in the Industry 4.0 age. Our attention to detail and the speed of production achieved by our new tooling allows us to deliver a service not yet experienced in our marketplace.

carbon zero

We take our social and environmental obligations very seriously. By sourcing raw materials and energy responsibly and investing heavily in the latest production techniques we can minimise our carbon footprint and are proud to offer, what we believe is, the first carbon neutral manufactured steel locker in the world.

our product

The Pure range is the result of many years of experience in the personal storage industry. We know everybody's requirements vary, so we have an unrivalled ability to adapt to most needs. Each product in our range has been reimagined and redesigned utilising our cutting-edge technology to ensure we offer a product to suit your requirements.

covid safe

At the heart of our own anti-bacterial coating, Bioshell, is Powdura® ECO powder coating from Sherwin-Williams. This COVID safe powder coating provides customers a more eco-conscious anti-bacterial solution to product protection, colour and performance.



Carbon zero manufacture
Carbon zero for scope 1 and 2 emissions 2022.



Zero to landfill
We reduce, reuse, re-purpose and recycle all waste generated by our operation.



No single use plastic
We have eliminated single use plastic from all of our packaging.



Carbon zero company
We will achieve net zero by 2025.



COVID safe coating
Our Bioshell powder coating incorporates an anti-bacterial ingredient.





pure design

Our innovative design provides a structurally strong locker which has been tested to comply with the locker testing standard BS4680:1990 yet has the aesthetics of an item of office furniture. Using the latest computer aided design facility directly linked to our production operation we can quickly adapt to changes in locker trends and any specific requirements.

pure benefits

Pure lockers can be positioned side by side, without the unsightly 'creep' gaps suffered by other brands. Our sidewalls have been developed to ensure creep is minimised, offering a far superior aesthetic.

A structural plinth between compartments for security, along with our unique shelf fixing mechanism provides an industry leading durable and robust locker.

Our locker frame and top cover are designed to be interlocked, reducing fixings and offering a significantly increased security threshold.

With through door locking, extra protection is provided at what would traditionally be the locker's weakest point, not any more.

Our in-door vents have been designed and developed to maximise airflow through an individual locker compartment while adding a stylish touch.

Our all-metric sizes offer an alignment with current ff&e design parameters.

Our lock offer will provide end-users with industry leading security options.

british made

Manufactured in our 64,000 square foot factory strategically located on Deeside in North Wales, we have easy access to the main arterial routes to all parts of the UK and Europe. We are proud to be part of the 'MADE IN BRITAIN' movement.



pure benefits & features



Dynamic card holder can accommodate a number plate



Specially designed high flow air vent system

(BS 4680: 1996)

(BS 6396: 2008+21:2015)

(industry4.0)
data driven technology

(10yr)
guarantee

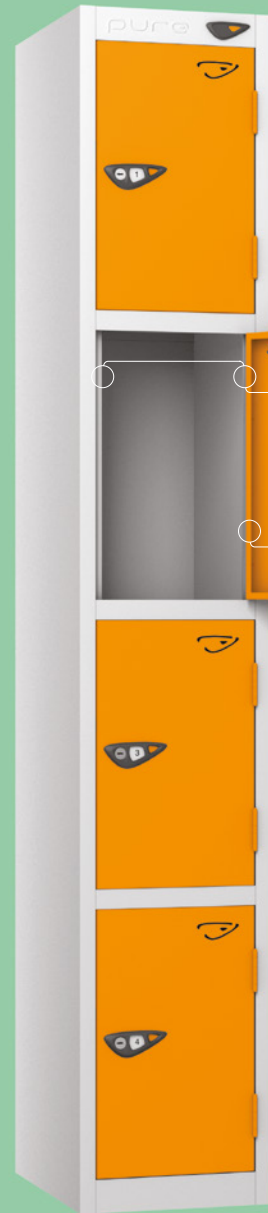

Stylish colour coded top badge which can be individually branded



increased security

Double return for higher levels of security

Secure through frame locking

Five knuckle hinge

(Flamezero)
fire tested and approved

(bioshell)
anti-bacterial coating

(CO2 zero)
carbon zero manufacture

- carbon zero manufacture
- doors vented aiding air flow
- through frame locking
- flamezero certificated
- made in britain
- high quality uk locks
- fully recyclable
- robust .3mm & .7mm thick steel
- covid safe finish - bioshell
- off set rivets on all products
- anti-intruder frame
- tested to bs standards



(magma/white)

pure design

We've re examined every detail and made improvements at every turn. Here's an example of how the little things count. By simply creating an indent for the rivet of an adjoining locker to locate, we've removed the creep that so often catches planners out when specifying quantity for a given space.

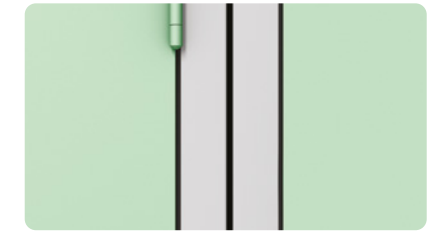

The visible gap between adjoining traditional lockers can be up to 4mm wide.

the pure solution

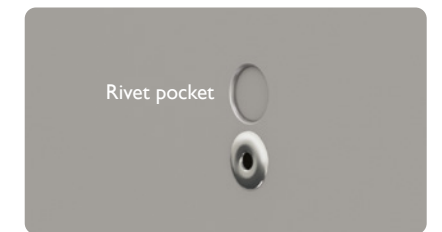
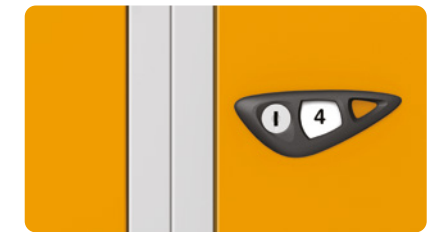

Our innovative solution is a simple rivet pocket and an offset rivet allowing lockers to sit flush with zero gap.





PURE



[white/silver/lime]

suitable
environments

Pure Lockers come in many colours, finishes, textures and sizes options and have been designed to suit many environments, such as:

- pharmaceutical
- care
- educational
- commercial
- industrial
- sports and social
- retail
- civil service
- emergency services
- mod Facilities
- correctional Facilities

In fact, we cannot think of a setting that is not suitable for Pure Lockers!

*See web for details and exclusions.

Pure reserve the right to alter design and specification without prior consent. All sizes displayed are nominal.



pure prime



Our standard range of superior lockers are manufactured from robust 0.9mm and 0.7mm thick steel, Pure lockers incorporate a range of unique features that make it one of the most stylish and adaptable lockers available. State of the art production capabilities allow us to manufacture a wide range of sizes to suit most requirements and budgets.

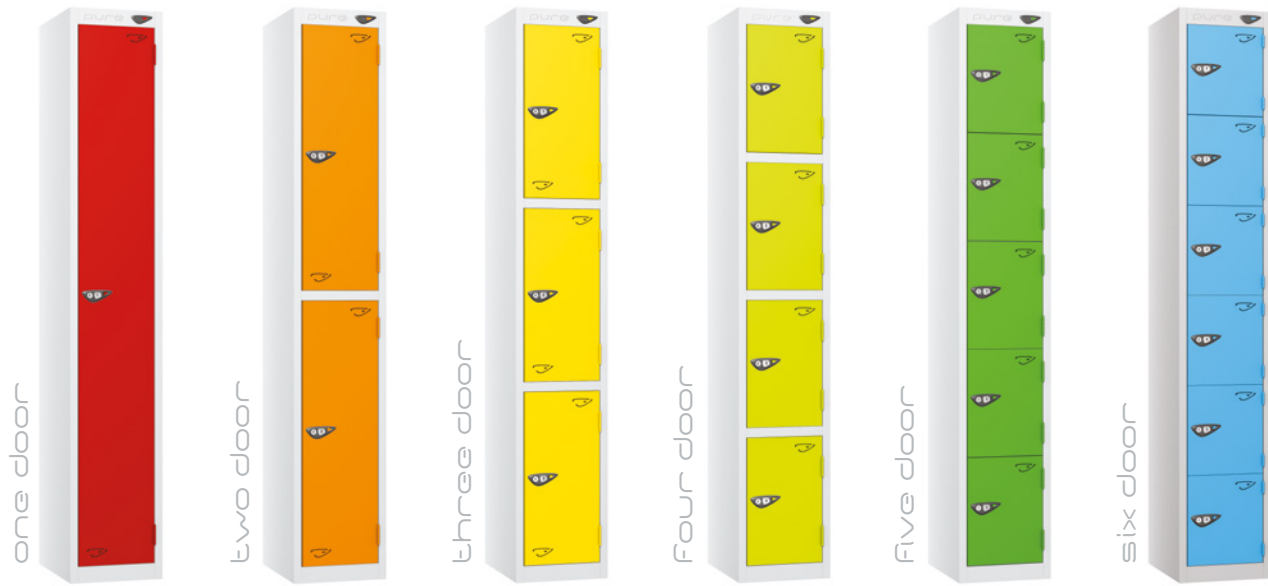

three widths and three depths available

retro fit sloping tops available

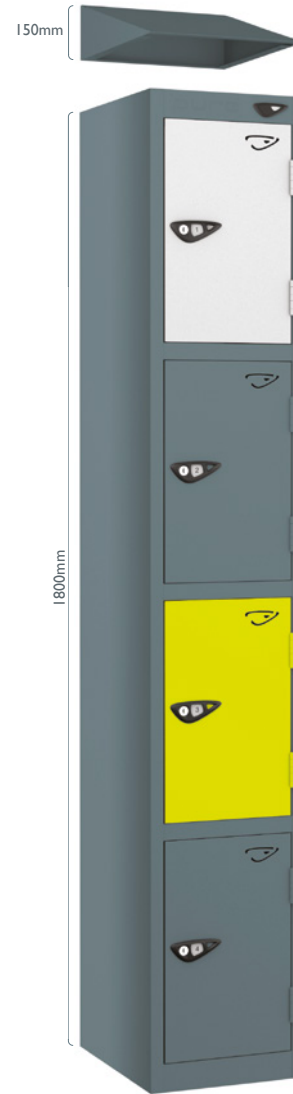

integral sloping tops available



pure workwear

Z² twin



We know that not everybody's needs are the same and some customers need a more specialised locker, so we have developed a range of lockers specifically for the leisure, education, healthcare and food industries. The range includes the popular Clean & Dirty, Janitor's/Uniform, Twin/Two-Person lockers. We can also introduce our reimagined Z locker offering two separate compartments for each of two users, one hanging and one shelf compartment.



clean & dirty

clean & dirty

Includes top shelf and two separate hanging compartments each with a coat hook.

Width 450mm
Depth 450mm
Height 1800mm



janitor's/uniform

janitor's/uniform

Includes top shelf, four side compartments and a hanging compartment with coat hook.

Width 450mm
Depth 450mm
Height 1800mm



twin/two-person

twin/two-person

two separate slim hanging compartments each with a coat hook and top shelf.

Width 450mm
Depth 450mm
Height 1800mm

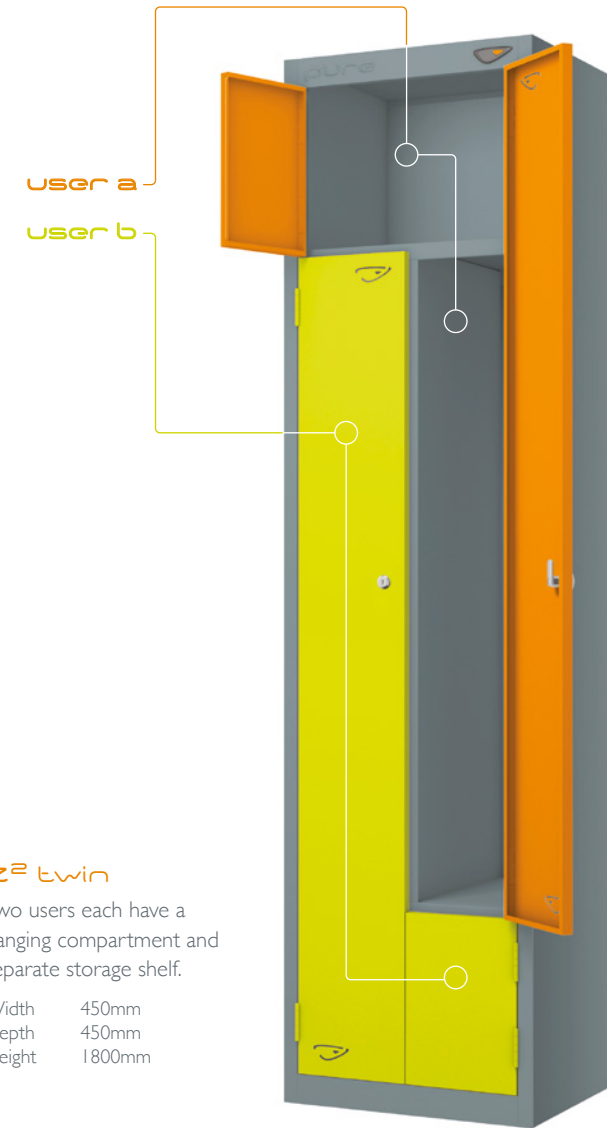

Z² twin

Two users each have a hanging compartment and separate storage shelf.

Width 450mm
Depth 450mm
Height 1800mm



*See web for details and exclusions.

Pure reserve the right to alter design and specification without prior consent. All sizes displayed are nominal.



pure small but mighty

Here are some of our small lockers ideal for infants and junior schools, also found in offices and universities alike. Pure lockers are great value for money, robust, hard wearing lockers designed for the toughest crowd.



cubed

cubed
300³ 300mm x 300mm x 300mm
380³ 380mm x 380mm x 380mm
450³ 450mm x 450mm x 450mm



quart

quart
Width 300mm
Depth 300mm
Height 450mm



three door infant

infant lockers

Ideal for schools but also at home in the office for low level storage.

Width 300mm
Depth 300mm
Height 1200mm



two door infant



one door infant



*See web for details and exclusions.

Pure reserve the right to alter design and specification without prior consent. All sizes displayed are nominal.

pure ppe

Pure steel body, robust PPE (Personnel Protective Equipment) lockers are available in sizes to meet most users needs. Our unique design eliminates 'locker creep' and unnecessary fixing holes. A wide range of locking options and accessories make this one of the most practical solutions for secure personnel storage. Lockers have the conventional blue doors and PPE stickers.

 Full medical range available

(10yr)
guarantee*

one door ppe



two door ppe

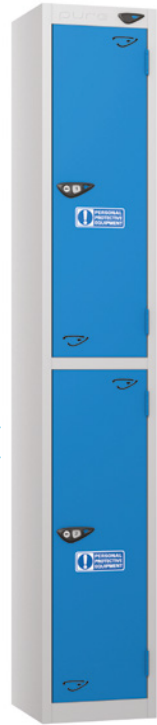

three door ppe



four door ppe



five door ppe



six door ppe



quart ppe



clean & dirty ppe



pure pearl silver
RAL 9006



pure cobalt blue
RAL 5012



clean & dirty

Includes top shelf and two separate hanging compartments each with a coat hook.

Width 450mm
Depth 450mm
Height 1800mm



pure pearl silver
RAL 9006



pure arctic white
RAL 9016



pure slate grey
RAL 7031



pure anti-stock theft



pure vision

Pure steel body, Pure vision lockers are available in sizes to meet most users needs. Our unique design eliminates 'locker creep' and unnecessary fixing holes. These lockers feature a window in each door for security inspection. A wide variety of locking options and accessories make this one of the most practical anti-stock theft solutions to personal storage in a wide variety of occupational applications where visual access to lockers is advantageous.

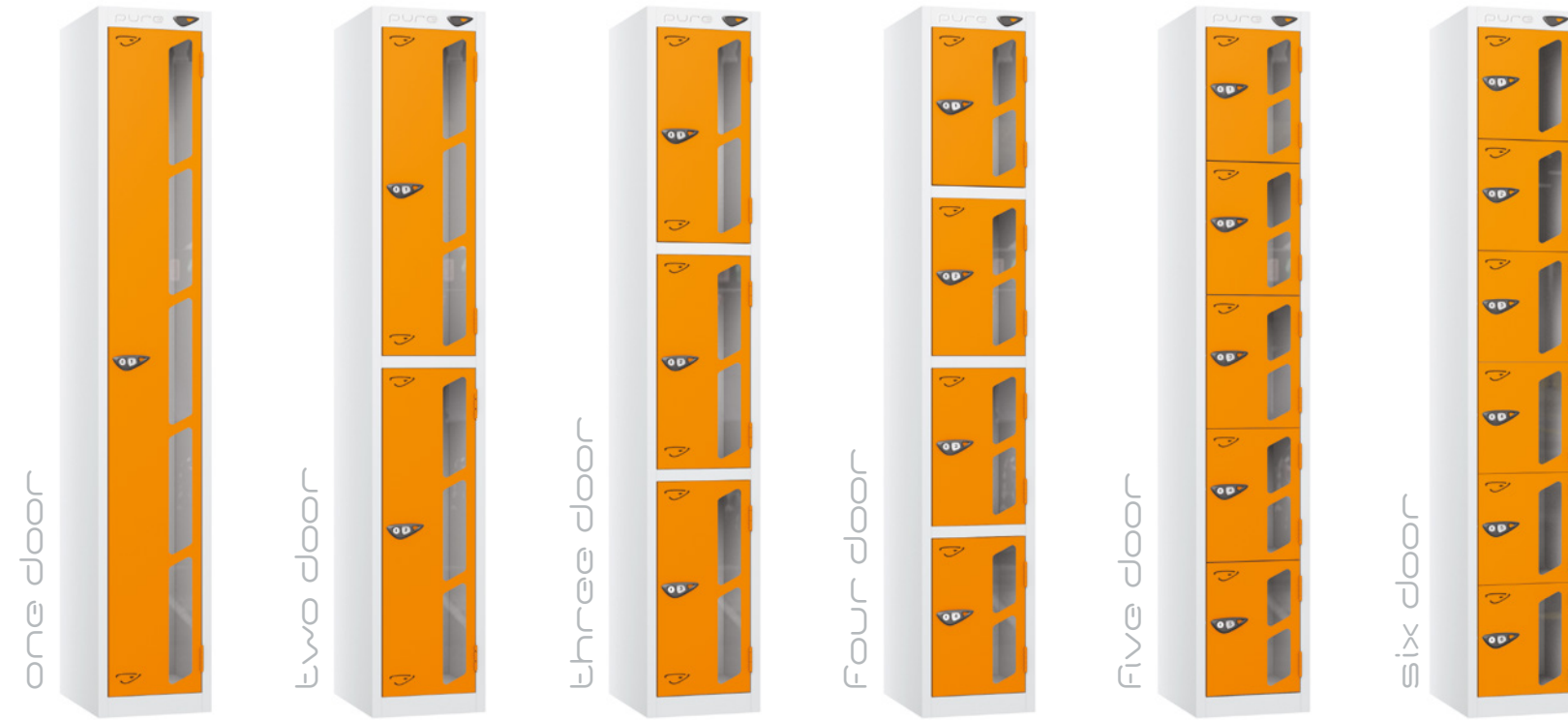

pure crystal

Pure steel body, Pure crystal lockers are available in sizes to meet most users needs. These lockers feature full vision doors. A wide variety of locking options and accessories make this one of the most practical anti-stock theft solutions to personal storage in a wide variety of occupational applications where visual access to lockers is needed.



pure specials

Here at Pure, we offer a huge range of storage solutions to meet most needs from general lockers to more specialised solutions for specific needs, here are just a few of the specialist lockers we offer. We can even create bespoke solutions in our state of the art, computerised, facility. Please enquire if you have a specification you'd like to discuss.

(pure bespoke)

Pure bespoke is a service designed to give you exactly what you need, from your own logo embossed at the top of a locker to a completely bespoke unit designed to fulfil your very specific needs. Please contact us to discuss your bespoke project.



maxi locker



maxi

This extra large locker cupboard is designed for those occasions when maximum storage is required.

Width 600mm
Depth 600mm
Height 1800mm

emergency services locker

This large locker cupboard is designed to accommodate the extra bulk of emergency services equipment.

Width 450mm
Depth 550mm
Height 1800mm



emergency services locker

wheelchair access



phone locker



fifteen compartment locker

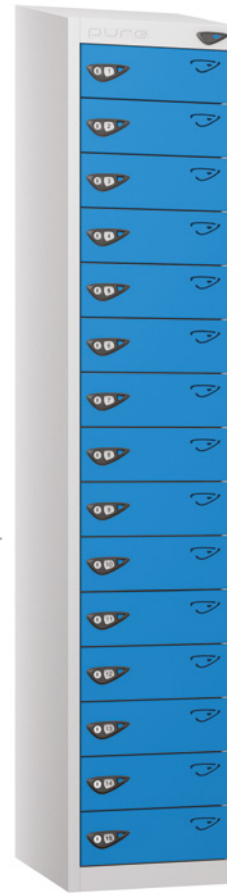

post locker

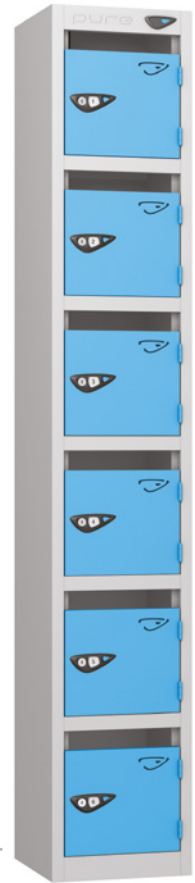

pure tablet power[®] or store[®]

Pure power lockers offer the highest quality power strips, available in 240volt, USB and USB-C. Each locker includes an IEC filter. Our range of power lockers have individually locked compartments or single door quick access compartments enabling secure access and charging, ideal for universities, schools and offices. Each unit is vented to prevent accumulation of heat. Lockers should always be secured to a wall for security and safety.



all powered lockers include an iec filter



charging



storage



eight door tab-charge



all available as storage only



all available with vision doors



eight compartment tab-charge



ten door tab-charge



ten compartment tab-charge



Fifteen door tab-charge



Fifteen compartment tab-charge

pure laptop power[Ⓢ] or store[Ⓢ]

Pure power lockers offer the highest quality power strips, available in 240volt, USB and USB-C. Each locker includes an IEC filter. Our range of power lockers have individually locked compartments or single door quick access compartments enabling secure access and charging, ideal for universities, schools and offices. Each unit is vented to prevent accumulation of heat. Lockers should always be secured to a wall for security and safety.



charging



storage



all powered lockers include an iec filter

choice of charging options available



usb option

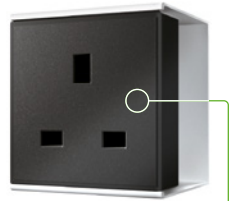

sixteen door trolley



eight door lap-charge



eight comp lap-charge



ten door lap-charge



ten comp lap-charge



fifteen door lap-charge



fifteen comp lap-charge

Pure reserve the right to alter design and specification without prior consent. All sizes displayed are nominal.

pure tool power[®]

Pure tool power lockers offer the highest quality power strips for re-charging power tool batteries, available in 240volt, USB and USB-C. Our tool power lockers have robust individually locked compartments enabling secure access and charging, ideal for sites with independent contractors. Each unit is vented to prevent accumulation of heat. Lockers should always be secured to a wall for safety. Each locker includes an IEC filter.



UK 3 pin socket in each compartment



all powered lockers include an iec filter

security features

Secure through frame locking

Double return for higher levels of security

Five knuckle hinge



pure power[®] specs

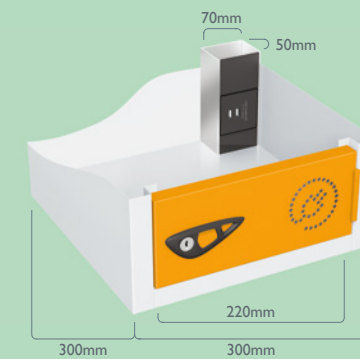
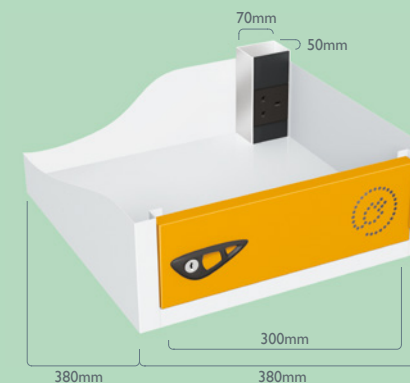

UK 3 pin socket PER COMPARTMENT

4 Tier	3.25A	750W
8 Tier	1.625A	375W
10 Tier	1.3A	300W
15 Tier	0.86A	200W
Trolley	1.625A	375W



usb-a & usb-c socket PER COMPARTMENT

4 Tier	2.0A	750W
8 Tier	1.625A	375W
10 Tier	1.3A	300W
15 Tier	0.86A	200W
Trolley	1.625A	375W

pure retro

Pure retro is a range of stylish lockers and cabinets designed with a nod to the past yet with a contemporary flavour. Whether you have a stylish boutique, a trendy apartment or a hipster hangout, these lockers will really cut a dash.

single door vintage

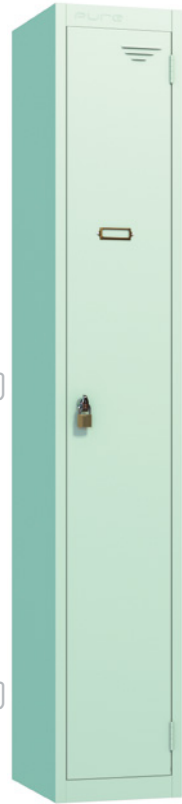

pure mint
RAL 6019



two door vintage



pure dusty pink
RAL 3015



three door vintage

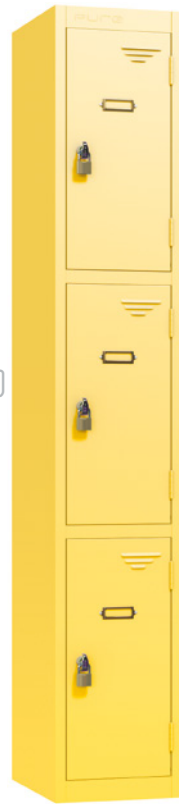

pure sunflower
RAL 1018



four door vintage



pure oyster
RAL 1013



retro



pure retro

Pure retro has its very own set of matching accessories including a brass coloured card holder, colour co-ordinated stands and a very special side unit exclusive to our Pure retro range.



pure dimensions

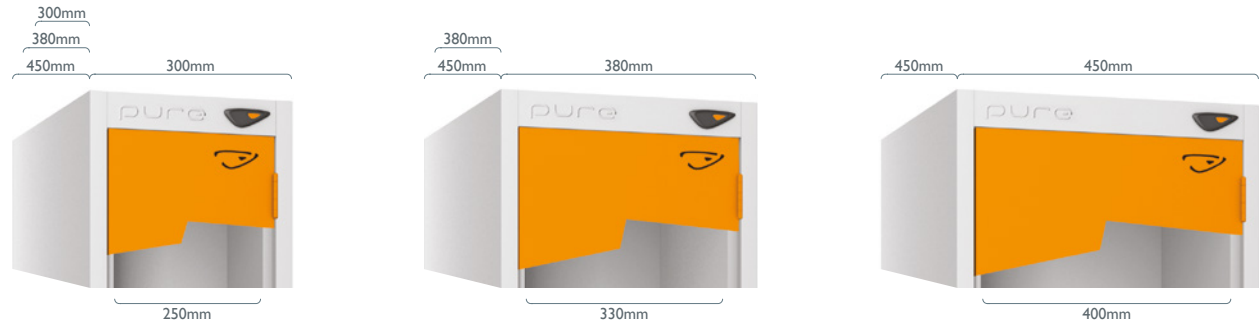

integral sloping tops

Clothing, rubbish and food left on top of lockers can be both a health and fire hazard. Our innovative sloping top design eliminates that unsightly gap at the top of the locker that can allow dirt and bacteria to accumulate. Not only does this design look better but it will be of particular benefit in sterile environments. Retro fit sloping tops also available.

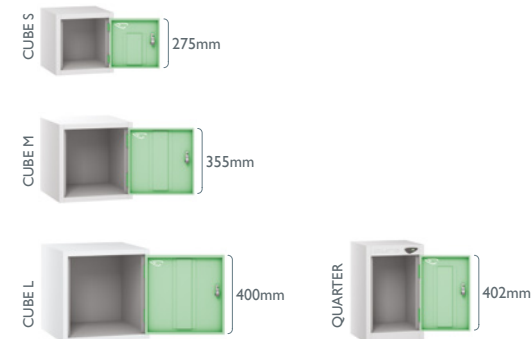
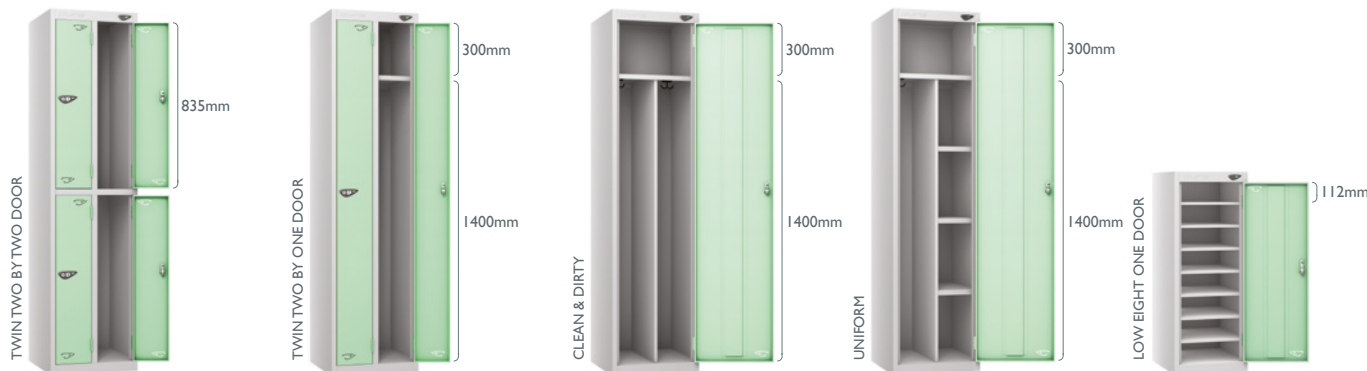
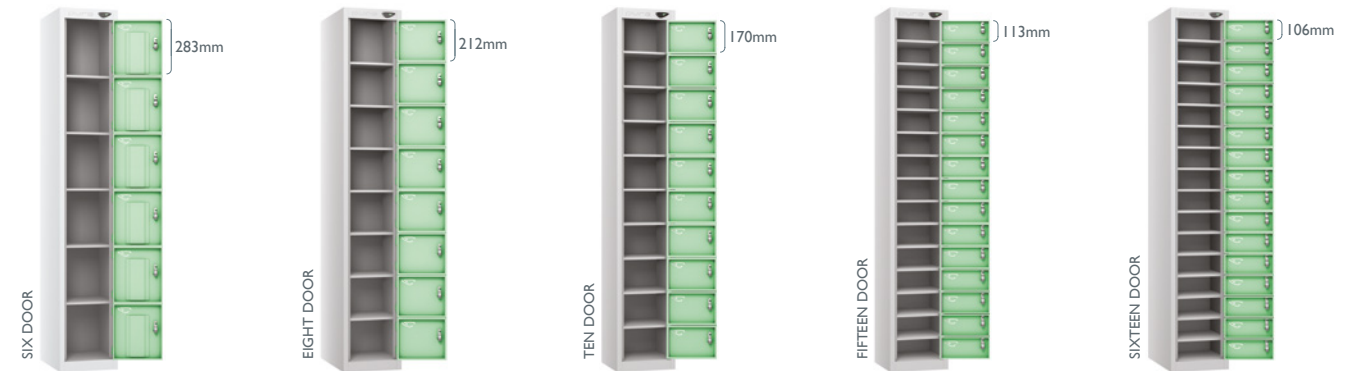
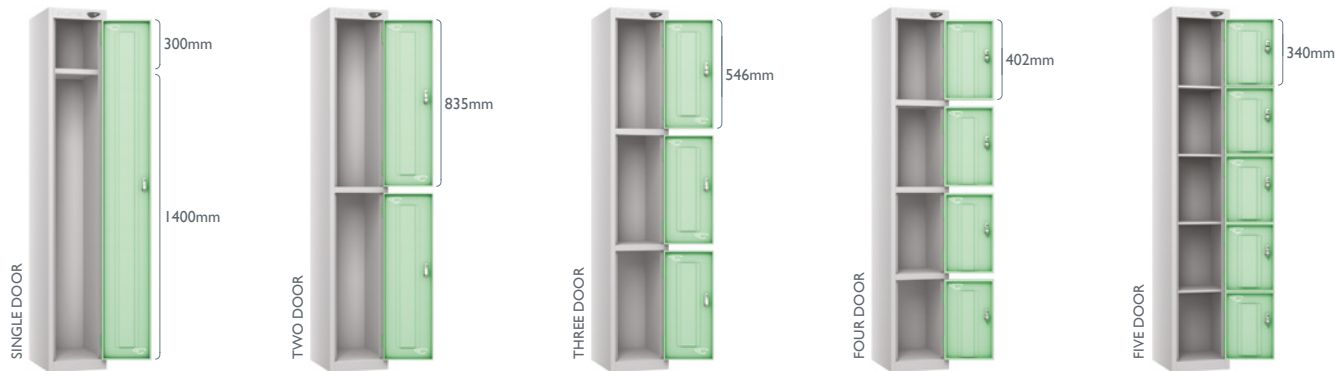

(Flamezero)
Are tested and approved

(zero)
2landfill

(bioshell)
anti-bacterial coating

(CO2)
ZERO

(BS 6396: 2008+21:2015)

(zero)
single use

(BS 4680: 1996)

(CO2)
ZERO



pure steel colours

door colours

pure slate grey
RAL 7031



pure pearl silver
RAL 9006



pure arctic white
RAL 9016



pure flame red
RAL 3020



pure magma
RAL 2003



pure lemon yellow
RAL 1018



pure forest green
RAL 6018



pure cobalt blue
RAL 5012



designer door colours

pure orchid violet
RAL 4005



pure cornflower blue
20 E 51



pure ribbon blue
18 E 50



pure mint
RAL 6019



pure lime light
12 E 51



pure slate grey
RAL 7031



pure pearl silver
RAL 9006



pure arctic white
RAL 9016



body colours

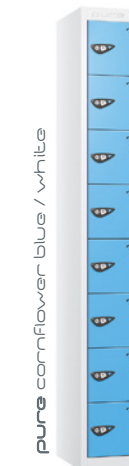
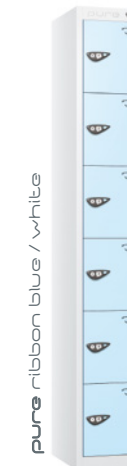

pure seats & stands

In some situations it is a requirement that staff can clean under lockers to prevent a build up of dirt and debris. This can also ease access to the bottom locker compartment. We can supply stands to lift the locker body from floor level. Usually 150mm high and fitted with adjustable feet to counteract uneven floors, these stands can be supplied in multiple locker widths to save cost and make installation easier:

Not all changing rooms have the available space to accommodate separate changing benches. To contend with this, we can supply a combined bench seat and stand. Benches have solid wood slats, can be manufactured in multiple locker widths and have the added benefit of allowing cleaning under the lockers.

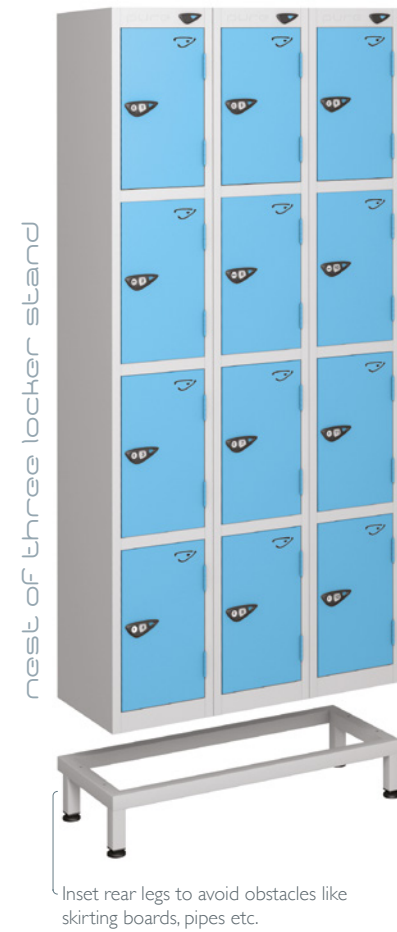
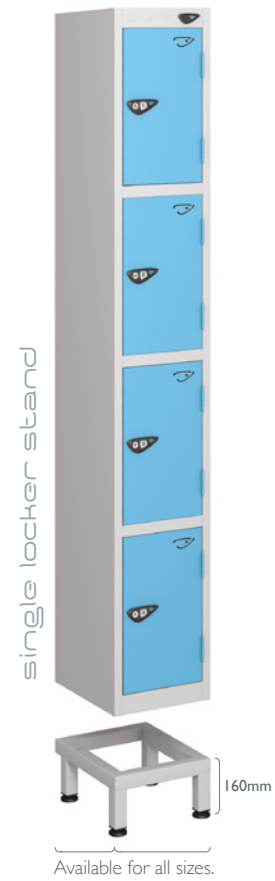

*See web for details and exclusions.

Pure reserve the right to alter design and specification without prior consent. All sizes displayed are nominal.

pure shield - sgl

Where appearance counts or locker doors need to withstand the rigours of heavy use, we have a range of solid grade laminate (SGL) door lockers. Our range of laminate surfaces and colours are made to match cubicle or furniture finishes. The sturdy composition of these doors allows the surface to withstand a great deal of punishment in demanding environments such as schools, universities, leisure facilities and many more.

pure benefits

The perfect combination of strength and aesthetics, these lockers have become widespread in educational and leisure applications where lockers are expected to both look good and withstand the rigours of severe use. Self closing hinges minimise damage to property and person, through door fixing provides a strong and secure door fastening. Multiple locking options from a simple padlock through to remote locker rental allocation and revenue. With a huge variety of colour finishes available through laminate manufacturers, the design possibilities are virtually limitless.

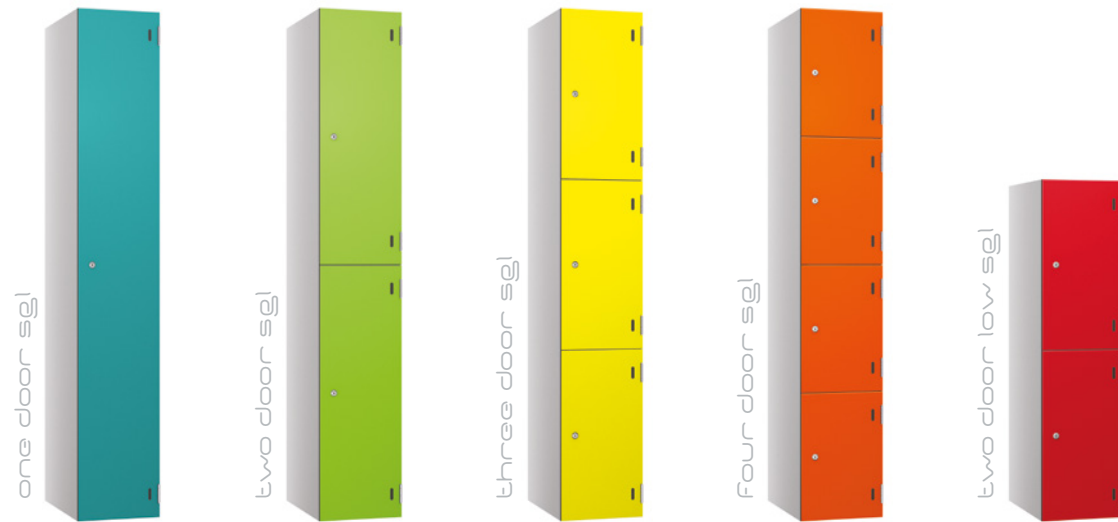

(10mm sgl)
solid grade laminate



180°
opening
hinge



optional
number
plates



(Flamezero)*
Fire tested and approved

(bioshell)
anti-bacterial coating

*Flame retardant sgl available on request.





Science



pure leisure - aluminium (12mm sgl)

solid grade laminate

(10yr)
guarantee*

This range of lockers has been designed to meet the specific needs of the leisure market. We understand the need to marry the two requirements of appearance and practicality in a challenging environment.

pure benefits

Robust self closing hinges, eliminate the danger of users colliding with open doors.

Aluminium bodies will not corrode in wet conditions, and solid grade laminate (SGL) doors and cover panels are not only highly water resistant, but also highly resistant to malicious damage.

Our extensive range of dry and wet area locks will protect users personal property. Whether it's key, padlock, coin operation or RFID swipe card we have a solution.

In conjunction with a wide range of accessories we can design, manufacture and install a full changing area scheme. We are not limited to a specific laminate manufacturer, we can provide doors that match cubicles or vanity fittings.

(water resistant)
suitable for wet environments



self closing hinge



optional number plates



wet area locks available





pure leisure - aluminium

In some situations it is a requirement that staff can clean under lockers to prevent a build up of dirt and debris. This can also ease access to the bottom locker compartment. We can supply stands to lift the locker body from floor level. Usually 150mm high and fitted with adjustable feet to counteract uneven floors, these stands can be supplied in multiple locker widths to save cost and make installation easier.

aluminium stands

(water resistant)
suitable for wet environments



These robust aluminium stands are constructed from 25mm square tube.

Not all changing rooms have the available space to accommodate separate changing benches. To contend with this, we can supply a combined seat and stand. Seats are topped with extremely tough 12mm solid grade laminate and can be manufactured in multiple widths giving the added benefit of allowing cleaning under the lockers.

aluminium seats & stands

(water resistant)
suitable for wet environments



These extremely robust aluminium seat & stands are constructed from 60mm x 40mm square section fully welded and laser cut.

Seats are constructed from 12mm solid grade laminate and are available in a huge range of colours to match cubicals.

pure sgl laminate colours

(12mm sgl) solid grade laminate (10mm sgl) solid grade laminate

• denotes stock colour

suitable for wet areas with our aluminium lockers

pg mysore ivory
RAL 1013



pg Frosty white
RAL 9010

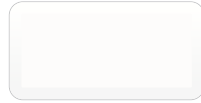

pg pearly white
RAL 9016

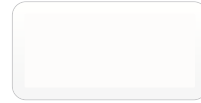

pg designer white
RAL 9003 ●

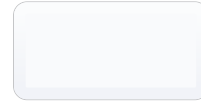

pg light grey
RAL N/A

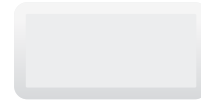

pg pearl grey
RAL 7038



pg bay
RAL 7032



pg dust
RAL 7004 ●



pg lime yellow
RAL 1016



pg lime
RAL 6018 ●



pg peacock
RAL 1905040



pg dark grey
RAL 7012 ●



pg ozone
RAL 5024 ●



pg electric blue
RAL 5005



pg blue galaxy
RAL 5000



pg tangerine
RAL 2004 ●



pg red dynasty
RAL 3018 ●



pg black
RAL 9005



pg mangfall beech
719



pg refresh oak
5427



pg brooks walnut
5018



pg clear mesh
5566



pg smoky mesh
5568



alternate colour ranges available on request

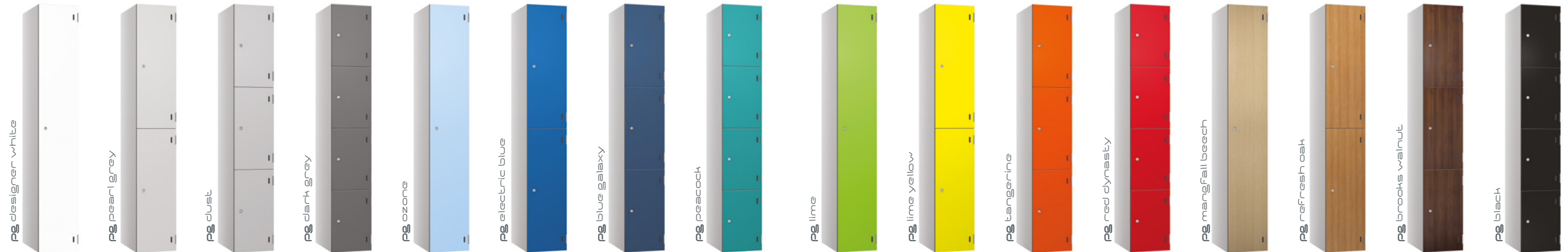

pure e><xtreme® plastic

Especially designed for 'extreme' environments, these hard wearing polyethylene lockers will withstand the most demanding conditions where conventional steel lockers would not be suitable.

pure benefits

Injection moulded from hard wearing, impact resistant plastic, these lockers will never rust or corrode. Adhering to our environmentally responsible principles, these lockers are fully recyclable. Designed for exposed outdoor conditions, the lockers are vandal resistant. The modular design permits a wide variety of configurations to fit into most spaces. We have an extensive range of different locking options that will suit most security needs.

(water resistant)
suitable for wet environments

- o highly water resistant
- o outdoor lockers
- o Food grade
- o anti-bacterial material
- o Fully recyclable

(biotech)
anti-bacterial material

Our attention to detail hasn't escaped these robust lockers, this time not just on the surface but incorporated into the material itself is our antibacterial formula.

1 number plates available

sloping tops available

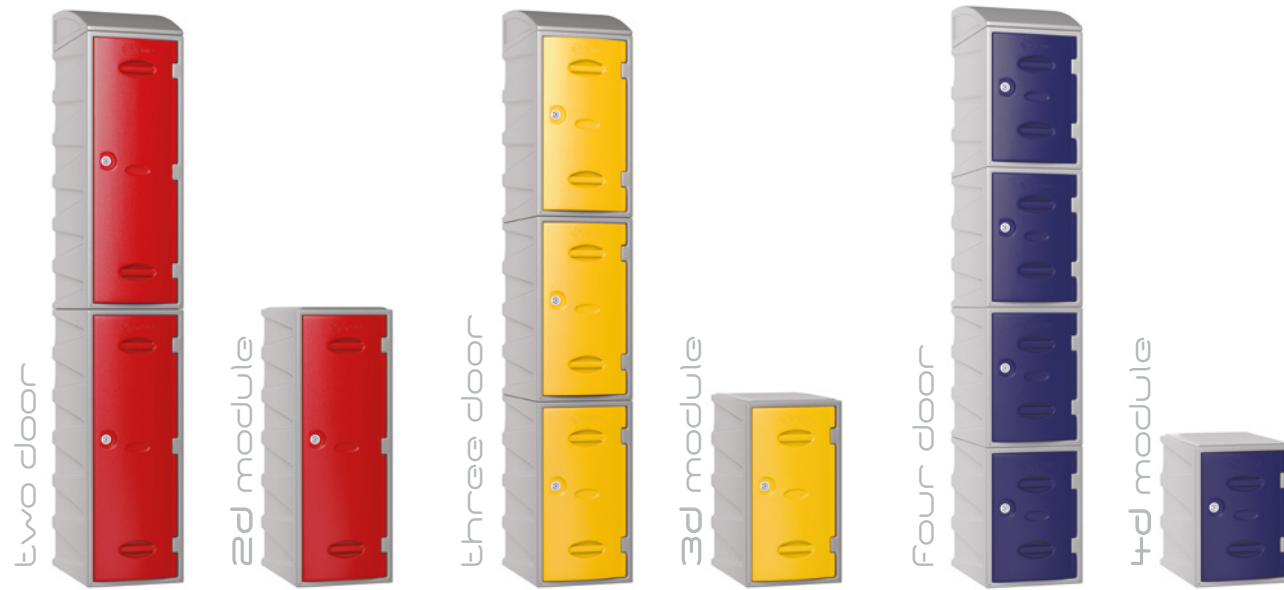

extreme pewter
RAL 7042



extreme red
RAL 3020



extreme gold
RAL 1003



extreme blue
RAL 5003



wet area locks available

*See web for details and exclusions.

Pure reserve the right to alter design and specification without prior consent. All sizes displayed are nominal.





(10yr)
guarantee*

eXtreme

- o highly water resistant
- o outdoor lockers
- o food grade
- o anti-bacterial material
- o fully recyclable

(water resistant)
suitable for wet environments

modula



pure eXtreme®

*See web for details and exclusions.

Pure reserve the right to alter design and specification without prior consent. All sizes displayed are nominal.



pure mfc door steel lockers



Introducing Pure laminate door lockers. Modern work and leisure environments sometimes require a more aesthetically pleasing piece of furniture. These lockers embody the strength and durability of a steel locker coupled with the stylish appearance of a laminate door locker. Matching end/infill decor panels can be added to enclose the unit.

(18mm mfc)
18mm mfc core laminated

- Hard wearing 18mm thick laminate door.
- PVC edging to virtually eliminate chipping.
- Self closing hinges.
- Extensive range of colours and finishes.
- Can be fitted with 'smart locks' suitable for agile workspaces.

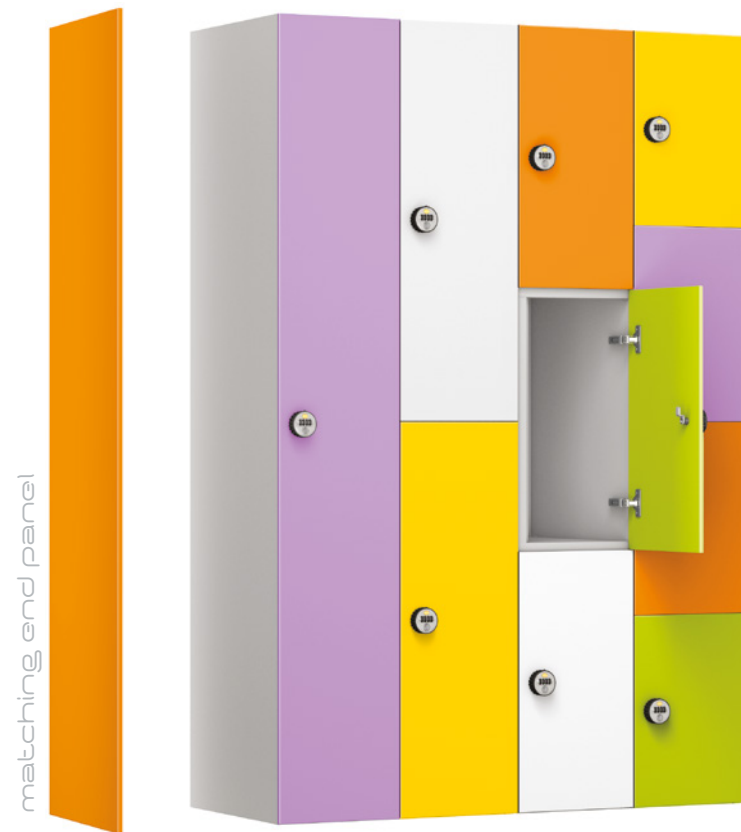

stock colours & finishes

mfc goldfish U279-BST	mfc lemon U285-BST	mfc sunshine U136-BST	mfc lavender U816-BST	mfc white	mfc grey	mfc granite F261-M02	mfc anthracite	mfc black	warm oak H440-Z5L	brown oak H782-W06	chocolate oak H441-Z5L	stone oak H783-W06	silver oak H595-W07



pure cloakroom

Many changing environments require a place to sit whilst changing clothes. Designed to withstand the rigours of heavy use, this range of pre-assembled cloakroom furniture is both strong and attractive. Supplied in 1000mm, 1200mm, 1500mm and 2000mm standard width modules in senior/adult, junior and primary seat heights. We know that most changing areas are different, so if the standard modules don't work, non-standard sizes are available and can be priced on application.

- **NEW robust design**
- **Solid steamed beach wood slats (FSC certified)**
- **Range of standard sizes to suit most applications, supplied ready built**
- **Anti-ligature polymer coat hooks with anti-microbial additive**
- **Frame and hook colours to co-ordinate or contrast with Pure steel lockers**
- **Floor or wall fixings available**



*See web for details and exclusions.

Pure reserve the right to alter design and specification without prior consent. All sizes displayed are nominal.



pure cloakroom



pure pearl silver
RAL 9006



pure cornflower blue
20 E 51



pure flame red
RAL 3020



pure magma
RAL 2003



pure lime light
12 E 51



4 lengths:

1000mm

1200mm

1500mm

2000mm

options:

o polymer slats

o baskets

3 heights available:

o senior/adult 1800mm
Seat height 450mm

o junior 1350mm
Seat height 400mm

o infant 1200mm
Seat height 350mm

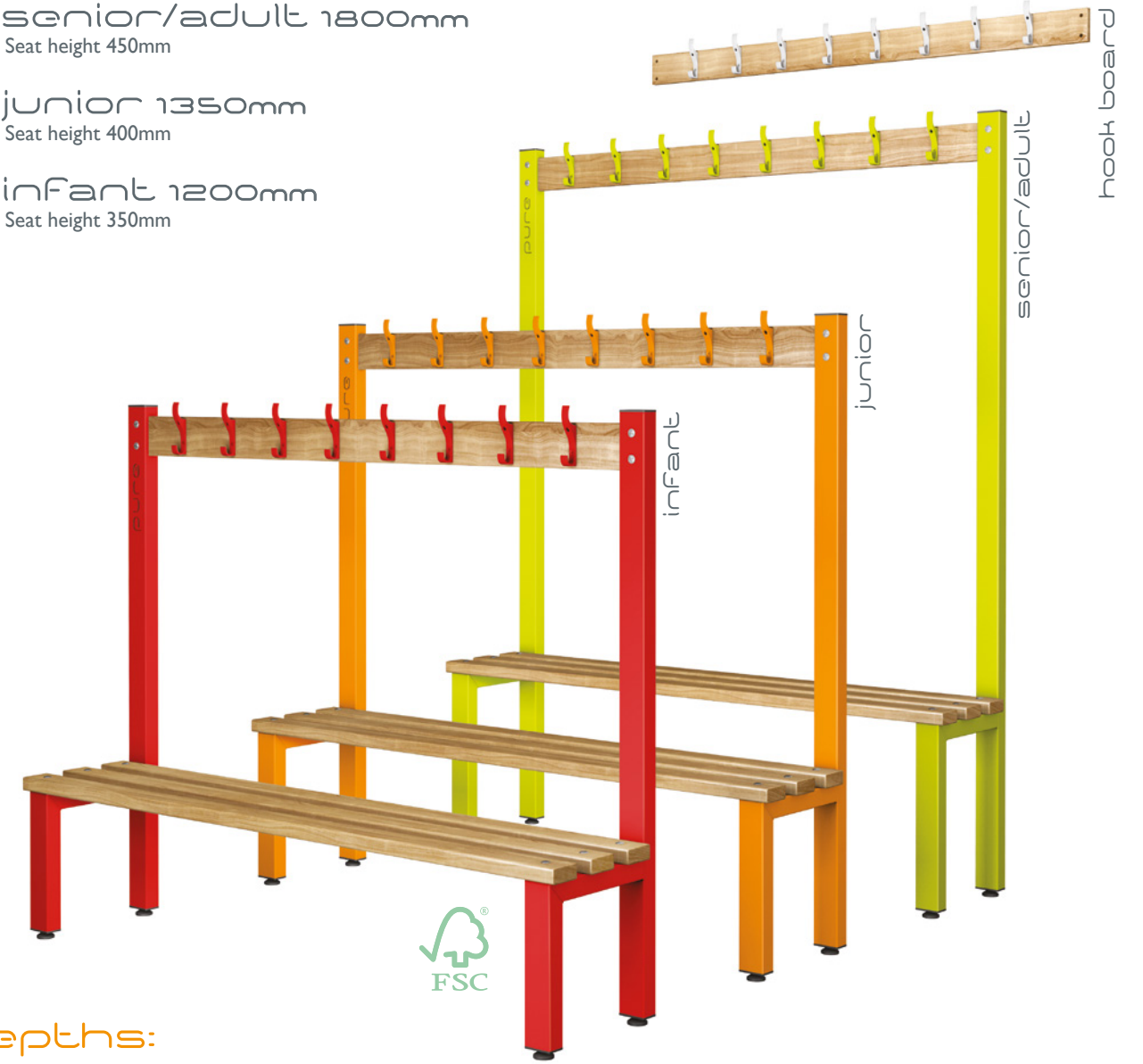

depths:

Double sided bench 775mm (790mm in black polymer)

Double sided hook and overhead bench 700mm (715mm in black polymer)

Single sided hook and overhead bench 370mm (375 in black polymer)

Single sided bench 305mm (310 in black polymer)





Standard cam lock
Our standard cam lock features 3000 serial combinations. Two keys are supplied with this lock.

- Available for:**
- Steel door lockers
 - Steel body - SGL doors
 - Steel body - MFC doors
 - Plastic body - plastic doors
 - Aluminium body - SGL doors

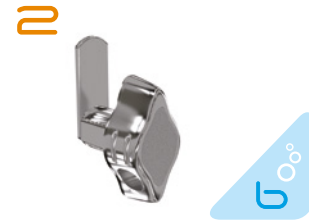

Standard hasp lock
This stylish hasp allows the use of a padlock with a maximum shank diameter of 7mm, minimum 5mm. Padlock sold separately.

- Available for:**
- Steel door lockers
 - Steel body - SGL doors
 - Steel body - MFC doors
 - Plastic body - plastic doors
 - Aluminium body - SGL doors



Premium cam lock with plastic key fob
Our high security premium cam lock features double entry key access and offers a higher level of security.

- Available for:**
- Steel door lockers
 - Steel body - SGL doors
 - Steel body - MFC doors



Secure hasp lock
This hasp offers a higher level of security over the standard hasp and also adds a touch of style to your locker.

- Available for:**
- Steel door lockers
 - Steel body - SGL doors
 - Steel body - MFC doors
 - Aluminium body - SGL doors



4 digit re-programmable lock
Available set as **private mode**, this 4 wheel mechanical combination lock features up to 10,000 unique combinations. For additional security the combination lock is also available with an optional 'twist resist' feature.

- Available for:**
- Steel door lockers
 - Steel body - SGL doors
 - Steel body - MFC doors
 - Plastic body - plastic doors
 - Aluminium body - SGL doors



4 digit re-programmable lock
Available set as **public mode**, this 4 wheel mechanical combination lock features up to 10,000 unique combinations. For additional security the combination lock is also available with an optional 'twist resist' feature.

- Available for:**
- Steel door lockers
 - Steel body - SGL doors
 - Steel body - MFC doors
 - Plastic body - plastic doors
 - Aluminium body - SGL doors



Digital combination lock
With a solid zinc alloy housing, 10-digit keypad, a secure key override as standard, the Zenith digital lock is the perfect choice for a wide variety of applications.

- Available for:**
- Steel door lockers
 - Steel body - SGL doors
 - Steel body - MFC doors
 - Aluminium body - SGL doors



RFID contactless digital lock
High strength Grivory makes this lock very robust, the lock can be used independently or paired with existing wireless systems. Steel override key available to bypass the contactless locking feature when immediate supervisory access is necessary.

- Available for:**
- Steel door lockers
 - Steel body - SGL doors
 - Steel body - MFC doors
 - Aluminium body - SGL doors



£1 coin/token return or retain
These self-service locks are simple and easy to use. This lock is available in two modes; **coin return** and **coin retain** (retain if used with the additional Coin box, opposite). In both modes the lock is controlled using a master key, available separately.

- Available for:**
- Steel door lockers
 - Steel body - SGL doors
 - Steel body - MFC doors
 - Plastic body - plastic doors
 - Aluminium body - SGL doors



Optional coin retain box
The Coin Box P004 attaches to the rear of the coin operated lock and retains any coins that are used to operate the lock.

- Available for:**
- Steel door lockers
 - Steel body - SGL doors
 - Steel body - MFC doors
 - Plastic body - plastic doors
 - Aluminium body - SGL doors



£1 door front coin return lock
£1 coin return lock offers a simple and cost effective solution for multiple occupancy locker/compartments. Ideal for use in changing rooms and general public areas. Can be retro fitted to most Pure locker doors. Lock supplied with two keys. Suitable for dry environments only. Master key available.

- Available for:**
- Steel door lockers
 - Steel body - SGL doors
 - Steel body - MFC doors
 - Plastic body - plastic door



RFID contactless circular lock
This is an environmentally friendly, low energy system using just one standard, easy to change, 1.5V AA battery. The transponder is available in cards, tags or wristbands. All transponders are easy to programme to master or user. Suitable for dry environments only. Master key available.

- Available for:**
- Steel door lockers
 - Steel body - SGL doors
 - Steel body - MFC doors
 - Plastic body - plastic door

